

**PLAN**

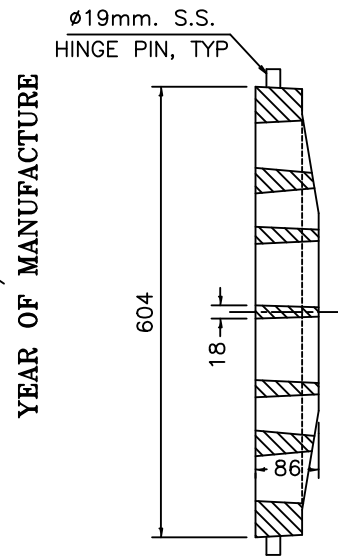

**SECTION-AA.**

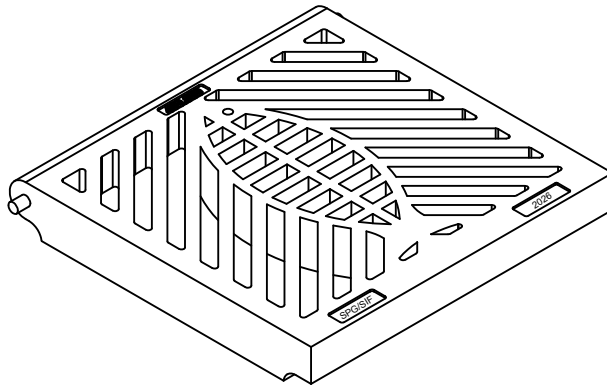

**ISOMETRIC 3D VIEW**

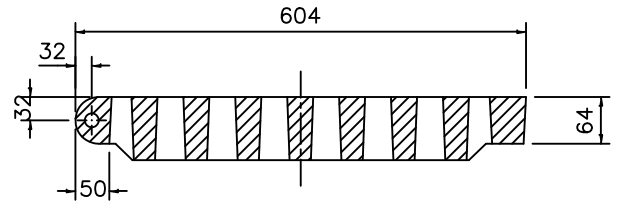

**SECTION-BB.**

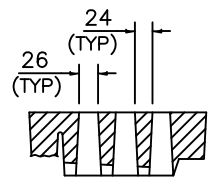

**SECTION-DD.**

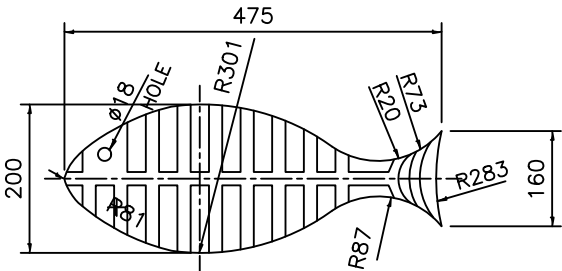

**FISH DETAIL**

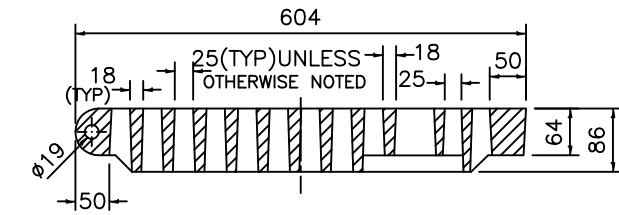

**SECTION-CC.**

**NOTES:**

1. All dimensions are in millimeter unless otherwise shown.
2. Material: Cast Iron ASTM A48 Clas 30B
3. Tolerance should be  $\pm 0.0625$ ", unless otherwise specified.
4. FINISH - UNPAINTED.

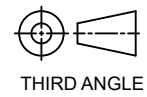
REV. NO	DATE		
	SIGN	DATE	
DRAWN	T.JANA	17.10.2025	 <p><b>APG Castings Inc.</b> Suite 232, 14-3650 Langstaff Rd, Woodbridge, ON, L4L 9A8</p>
CHECKED	M. GANGULY	17.10.2025	
QA			<p><b>TITLE :- H. DUTY "FISH" CATCH BASIN GRATE (OPSD 400.05)</b></p>
MFG			
APPRVD BUYER			<p>SCALE: NTS</p>  <p>THIRD ANGLE</p>
ESTMTD. WT			<p>DWG NO :-</p> <p>LOAD RATING :</p> <p>PAIN: UNPAINTED</p> <p>Material:- CAST IRON</p> <p>SHEET : 1 OF 1</p>