

FRAME PLAN

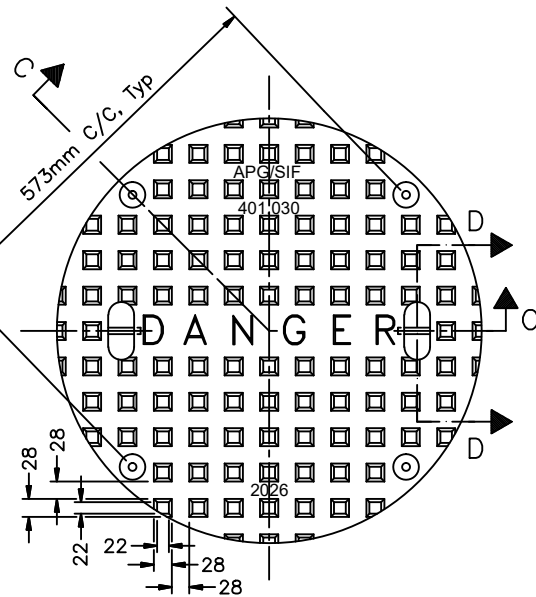

COVER PLAN

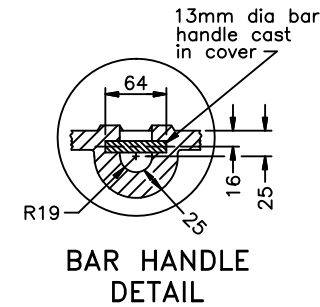

BAR HANDLE DETAIL

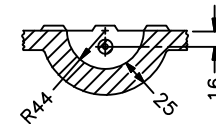

SECTION D-D

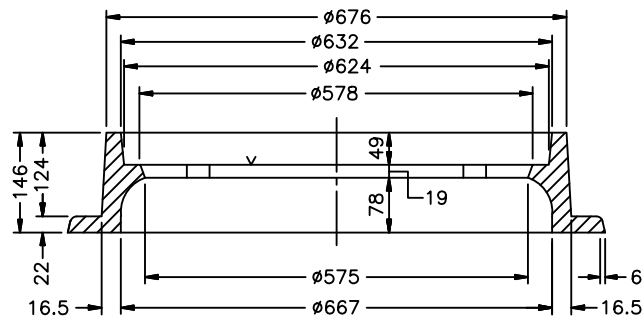

SECTION A-A

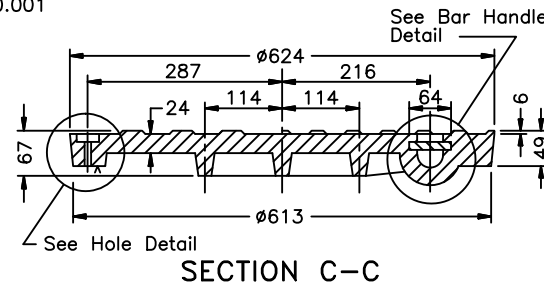

SECTION C-C

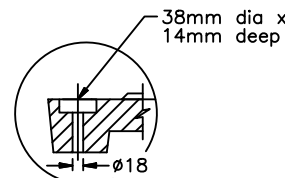

HOLE DETAIL

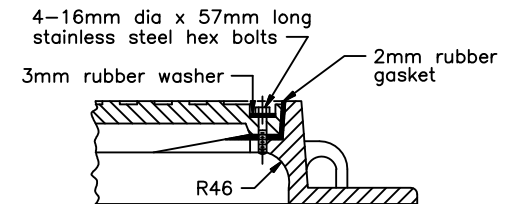

SECTION B-B

NOTES:

1. All dimension are in millimeter unless otherwise shown.
2. Material: Cast Iron ASTM A48 Clas 30B
3. Tolerance should be ± 0.0625 ", unless otherwise specified.

REV. NO	DATE	SIGN	DATE	 <p>APG Castings Inc. Suite 232, 14-3650 Langstaff Rd, Woodbridge, ON, L4L 9A8</p>
DRAWN	T.JANA	17.10.2025		
CHECKED	M. GANGULY	17.10.2025		
QA				
MFG				<p>TITLE :- OPSD 401.030</p>
APPRVD BUYER				
ESTMTD. WT				<p>SCALE: NTS</p> <p>THIRD ANGLE</p>
				<p>DWG NO :-</p> <p>LOAD RATING :</p> <p>PAINT: UNPAINTED</p>
				<p>Material:- CAST IRON</p> <p>SHEET : 1 OF 1</p>