

FRAME PLAN

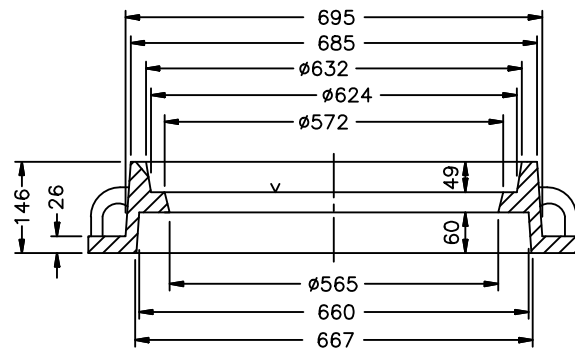

SECTION A-A

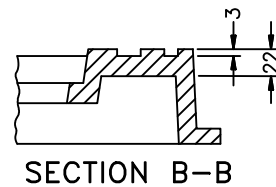

SECTION B-B

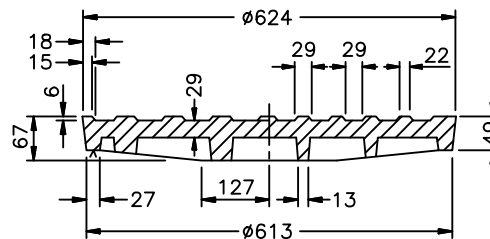

SECTION C-C

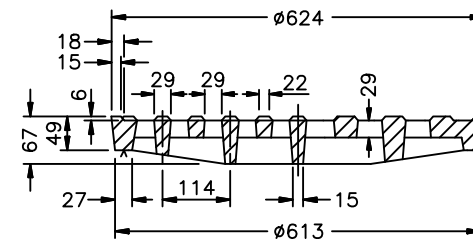

SECTION D-D

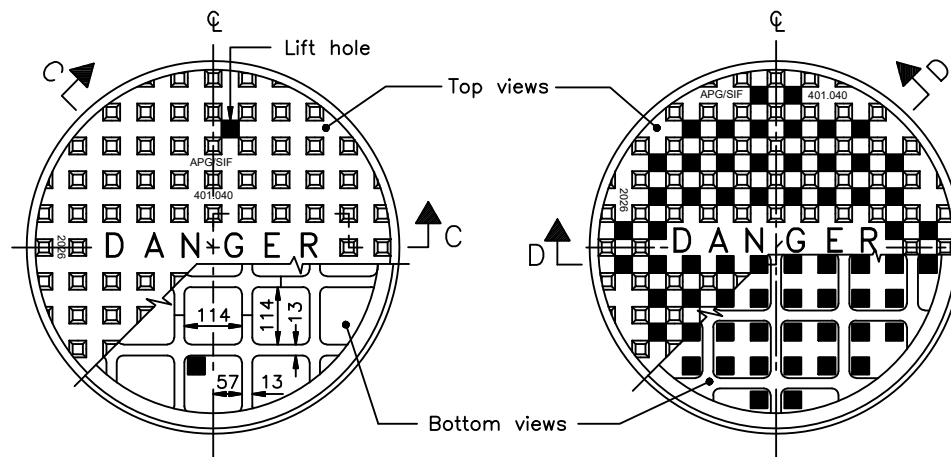

TYPE A
CLOSED COVER

TYPE B
OPEN COVER

NOTES:

1. Covers shall be type A or Type B, as specified.
2. All dimension are in millimeter unless otherwise shown.
3. Material: Cast Iron ASTM A48 Clas 30B
4. Tolerance should be $\pm 0.0625"$, unless otherwise specified.

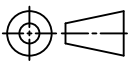
REV. NO	DATE			
	SIGN	DATE		
DRAWN	T.JANA	17.10.2025		
CHECKED	M. GANGULY	17.10.2025		
QA				
MFG				
APPRVD				
BUYER				
ESTMTD. WT				
				
			APG Castings Inc. Suite 232, 14-3650 Langstaff Rd, Woodbridge, ON, L4L 9A8	
			TITLE :- OPSD 401.040	
SCALE				DWG NO :- LOAD RATING :
NTS		THIRD ANGLE		PAINT: UNPAINTED
				Material:- CAST IRON SHEET : 1 OF 1